

UKŁAD NA PALECIE:

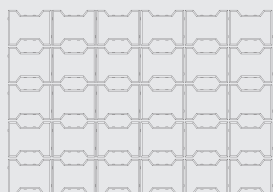

**BUDOKOP** | BETON

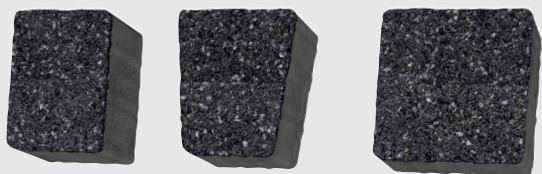

UKŁAD NA PALECIE:

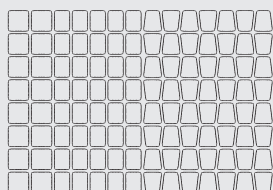

# BEHATON

1. z fazą
2. z nano fazą

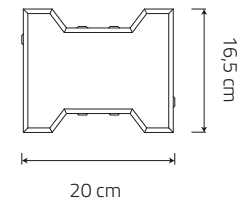

## WYMIARY

16,5x20x8

## MATERIAŁ

BETON

## KOLORYSTYKA



grafit



czerwony



szary

## PRODUKT

K-003

## GRUBOŚĆ

8

## ILOŚĆ NA PALECIE

7,56M<sup>2</sup>

## WAGA PALETY

1323 KG

## ILOŚĆ WARSTW

9

# ARCO

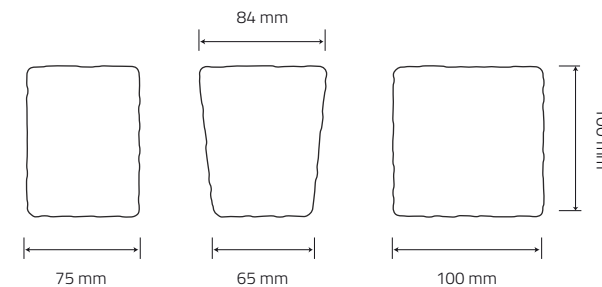

## WYMIARY

10x10x6  
7,5x10x6  
8,4x10x6

## MATERIAŁ

BETON

## KOLORYSTYKA



grafit



czerwony



biała płukanka



czarna płukanka

## PRODUKT

X

## GRUBOŚĆ

6

## ILOŚĆ NA PALECIE

9M<sup>2</sup>

## WAGA PALETY

1500 KG

## ILOŚĆ WARSTW

10

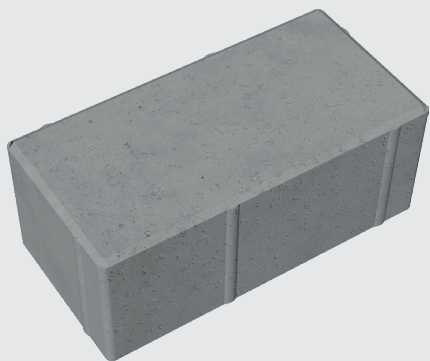

UKŁAD NA PALECIE:

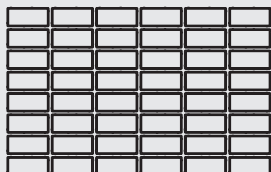

**BUDOKOP** | BETON



UKŁAD NA PALECIE:

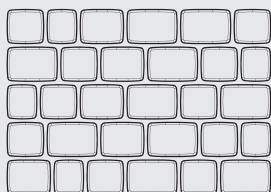

# HOLLAND

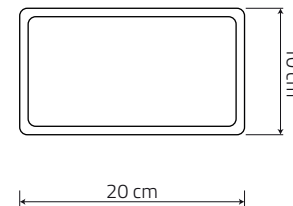

## WYMIARY

10x20x8  
10x20x6

## MATERIAŁ

BETON

## KOLORYSTYKA



grafit

czerwony

szary

## PRODUKT

## GRUBOŚĆ

## ILOŚĆ NA PALECIE

## WAGA PALETY

## ILOŚĆ WARSTW

K-004

8

8,64 M<sup>2</sup>

1510 KG

9

K-004

6

11,52 M<sup>2</sup>

1440 KG

12

# CUBICO

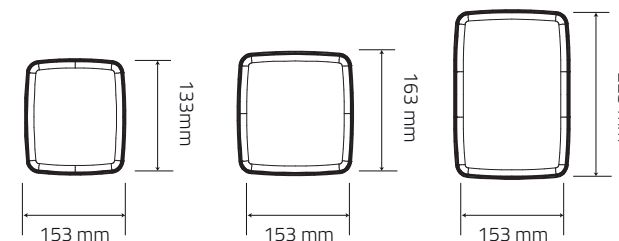

## WYMIARY

13x15x8  
16x15x8  
22x15x8

## MATERIAŁ

BETON

## KOLORYSTYKA



grafit

czerwony

płukanka biała

płukanka czarna

## PRODUKT

## GRUBOŚĆ

## ILOŚĆ NA PALECIE

## WAGA PALETY

## ILOŚĆ WARSTW

K-007

8

9M<sup>2</sup>

1500 KG

9



UKŁAD NA PALECIE:

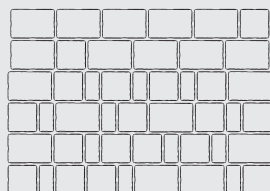

**BUDOKOP** | BETON

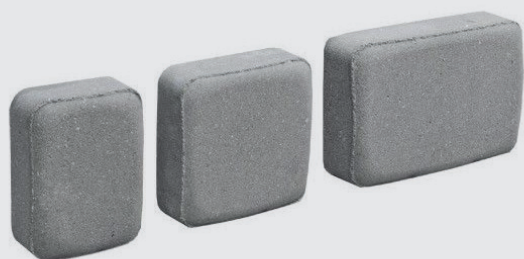

UKŁAD NA PALECIE:

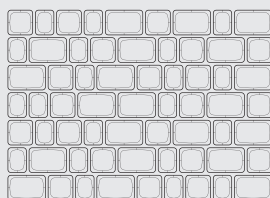

# LUNA

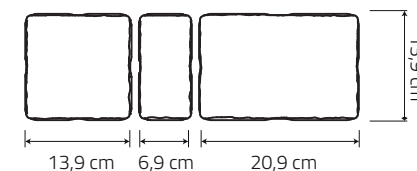

## WYMIARY

14x21x6  
14x7x6  
14x14x6

## MATERIAŁ

BETON

## KOLORYSTYKA



grafit

szary

czerwony

brązowy

## PRODUKT

K-009

## GRUBOŚĆ

6 CM

## ILOŚĆ NA PALECIE

10 M<sup>2</sup>

## WAGA PALETY

1315 KG

## ILOŚĆ WARSTW

10

# NOSTALIT

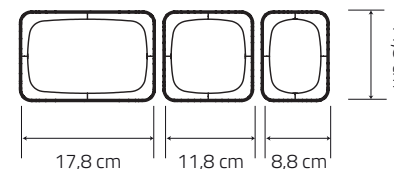

## WYMIARY

12x12x6  
12x9x6  
12x18x6

## MATERIAŁ

BETON

## KOLORYSTYKA



grafit

szary

czerwony

brązowy

żółty

## PRODUKT

K-010

## GRUBOŚĆ

6 CM

## ILOŚĆ NA PALECIE

10 M<sup>2</sup>

## WAGA PALETY

1312 KG

## ILOŚĆ WARSTW

10



UKŁAD NA PALECCIE:

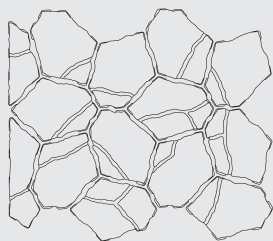

**BUDOKOP** | BETON

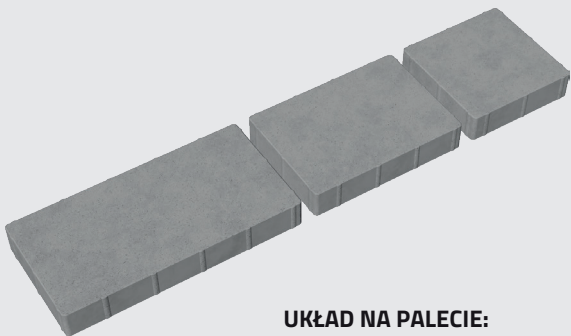

UKŁAD NA PALECCIE:

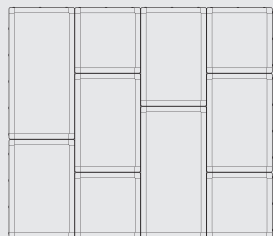

# SASSO

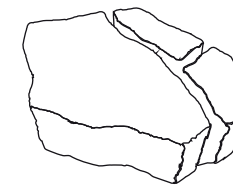

## WYMIARY

22x15x8

## MATERIAŁ

BETON

## KOLORYSTYKA



grafit



czerwony



szary



żółty

## PRODUKT

X

## GRUBOŚĆ

-

## ILOŚĆ NA PALECCIE

- M<sup>2</sup>

## WAGA PALETY

- KG

## ILOŚĆ WARSTW

-

# UMBRIANO

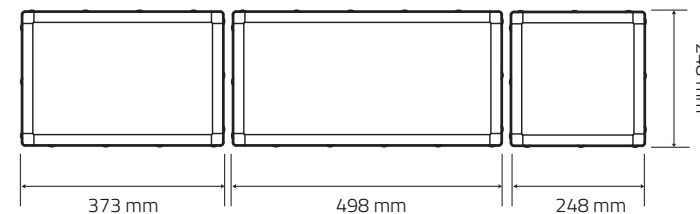

## WYMIARY

37x25x6

50x25x6

25x25x6

## MATERIAŁ

BETON

## KOLORYSTYKA



grafit



szary



czerwony



brązowy



żółty

## PRODUKT

K-007

## GRUBOŚĆ

6

## ILOŚĆ NA PALECCIE

9M<sup>2</sup>

## WAGA PALETY

1500 KG

## ILOŚĆ WARSTW

9

# KRAWĘŻNIK DROGOWY LEKKI

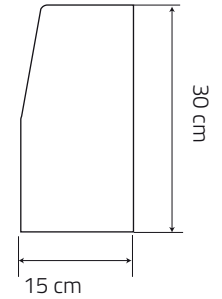
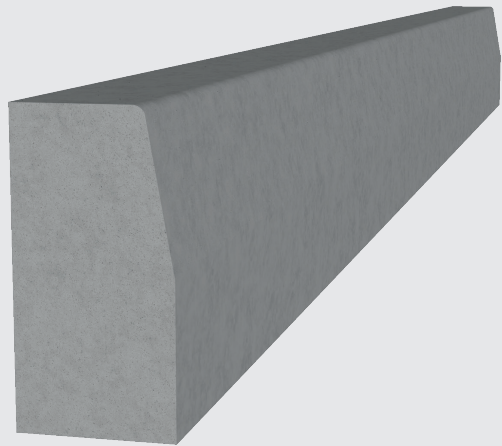

## WYMIARY

15x30x100

## MATERIAŁ

BETON

## KOLORYSTYKA



szary

## PRODUKT

X

## GRUBOŚĆ

15 CM

## ILOŚĆ NA PALECIE

12 SZT.

## WAGA PALETY

1200 KG

## ILOŚĆ WARSTW

2

 BUDOKOP | BETON

# KRAWĘŻNIK NAJAZDOWY LEKKI

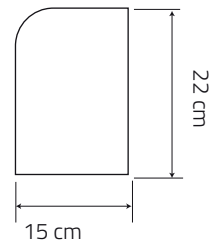
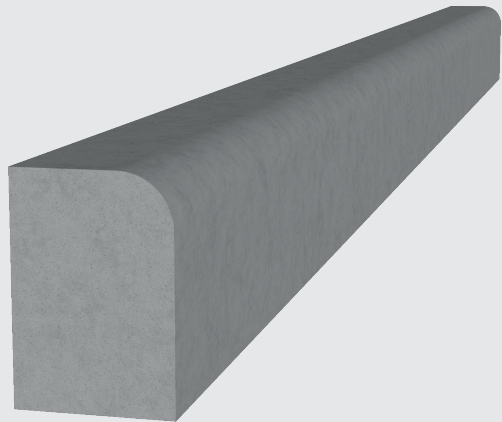

## WYMIARY

15X22X100

## MATERIAŁ

BETON

## KOLORYSTYKA



szary

## PRODUKT

-

## GRUBOŚĆ

15 CM

## ILOŚĆ NA PALECIE

15 SZT.

## WAGA PALETY

1170 KG

## ILOŚĆ WARSTW

3

\*wkrótce

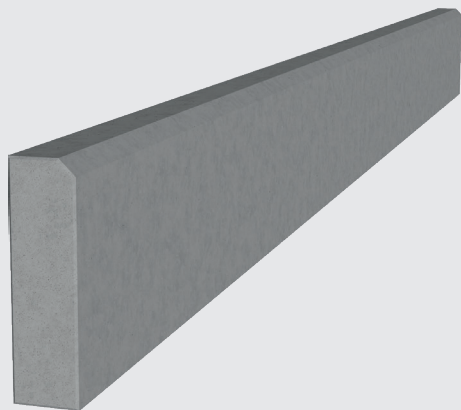

# OBRZEŻE

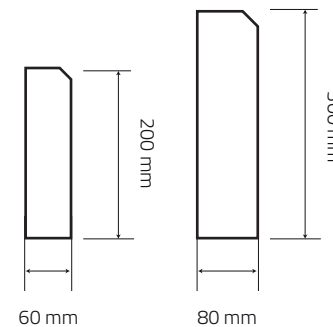

## WYMIARY

8X30X100  
6X20X100

## MATERIAŁ

BETON  
BETON

## KOLORYSTYKA



grafit      czerwony      szary

## PRODUKT

## GRUBOŚĆ

## ILOŚĆ NA PALECIE

## WAGA PALETY

## ILOŚĆ WARSTW

-	6	36 SZT.	972 KG	3
-	8	27 SZT.	1458 KG	3

 BETON

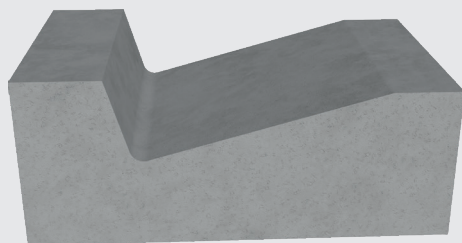

# PŁYTA ŚCIEKOWA TYP TRÓJKĄTNY

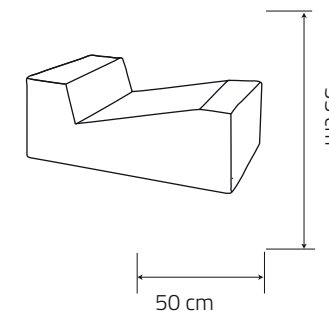

## WYMIARY

50x20X33

## MATERIAŁ

BETON

## KOLORYSTYKA



szary

## PRODUKT

## GRUBOŚĆ

## ILOŚĆ NA PALECIE

## WAGA PALETY

## ILOŚĆ WARSTW

-	-	24 SZT.	1512 KG	3
---	---	---------	---------	---

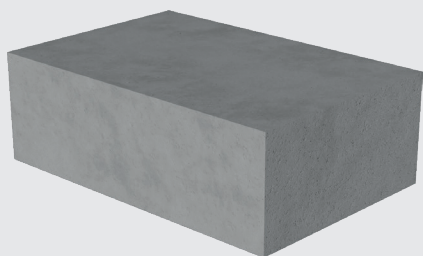

# BLOCZEK BETONOWY

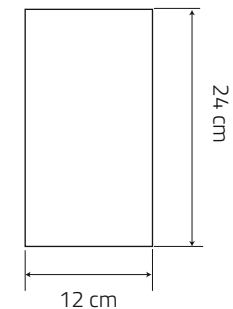

## WYMIARY

12x24x36

## MATERIAŁ

BETON

## KOLORYSTYKA



szary

## PRODUKT

X

## GRUBOŚĆ

12 CM

## ILOŚĆ NA PALECIE

54 SZT.

## WAGA PALETY

1242 KG

## ILOŚĆ WARSTW

3

\*wkrótce

 BUDOKOP | BETON

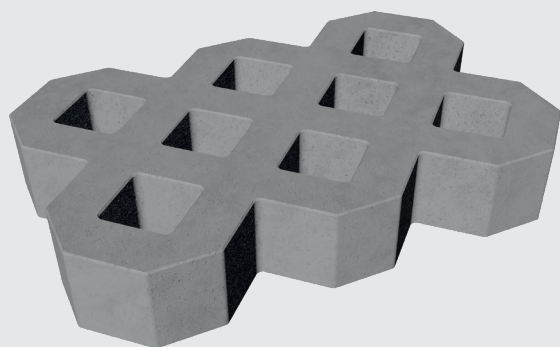

# PŁYTA AŻUROWA MEBA

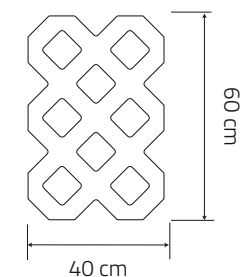

## WYMIARY

60X40X10

## MATERIAŁ

BETON

## KOLORYSTYKA



szary

## PRODUKT

-

## GRUBOŚĆ

10 CM

## ILOŚĆ NA PALECIE

6,72 m<sup>2</sup>

## WAGA PALETY

994 KG

## ILOŚĆ WARSTW

7